



8

8

8

H4

8

7

个

个

个

仔

个

与

个

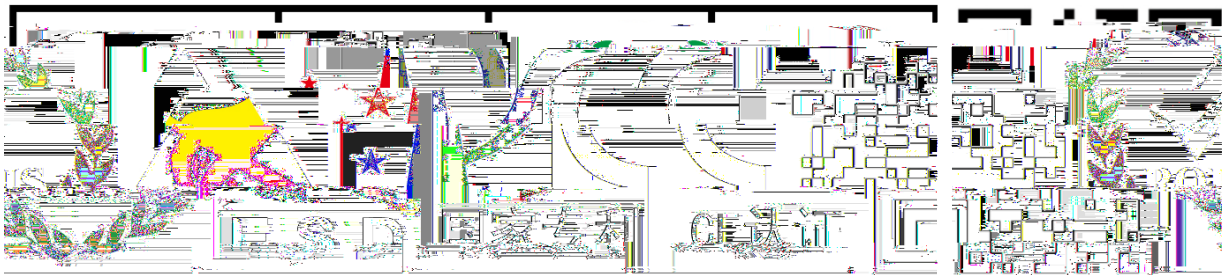

K



8

8

8

H4

8

7

↑

仔

仔

↑

仔			
仔			
仔			



8

8

8

H4

8

7



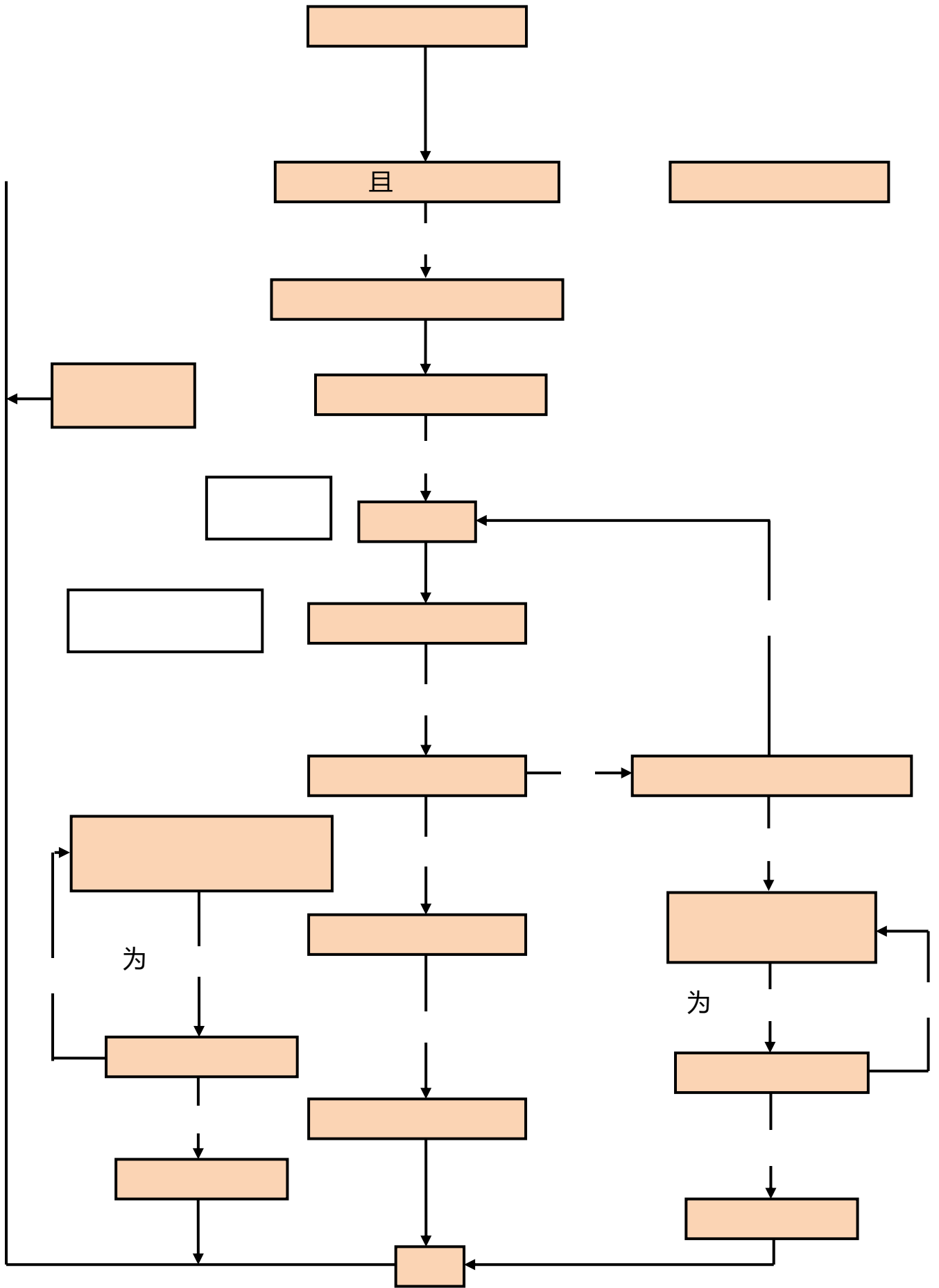



8

8

8

H4

8

7

九

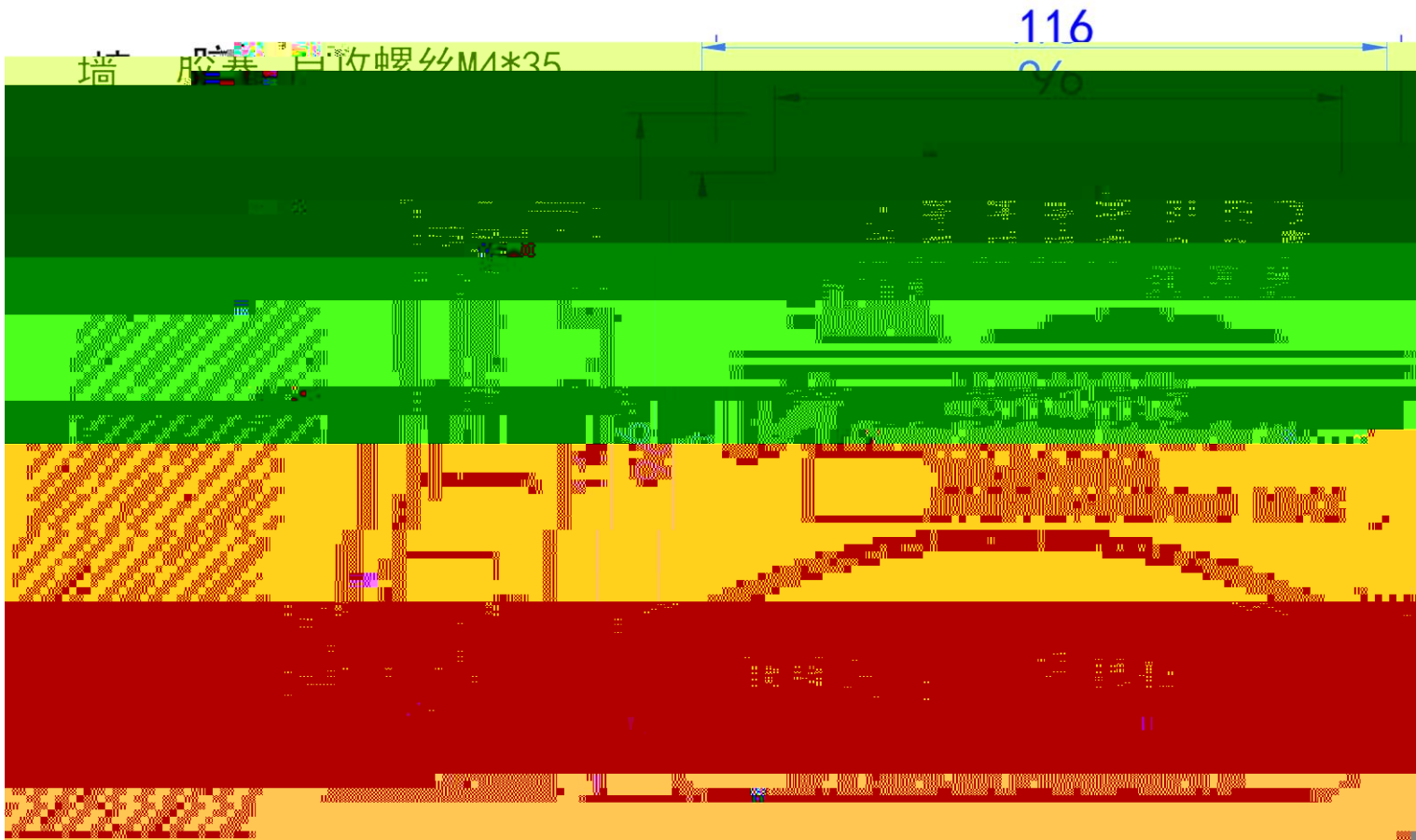

K



8

8

8

H4

8

7



输入AC 110V-220V



图 1
水泵控制原理图

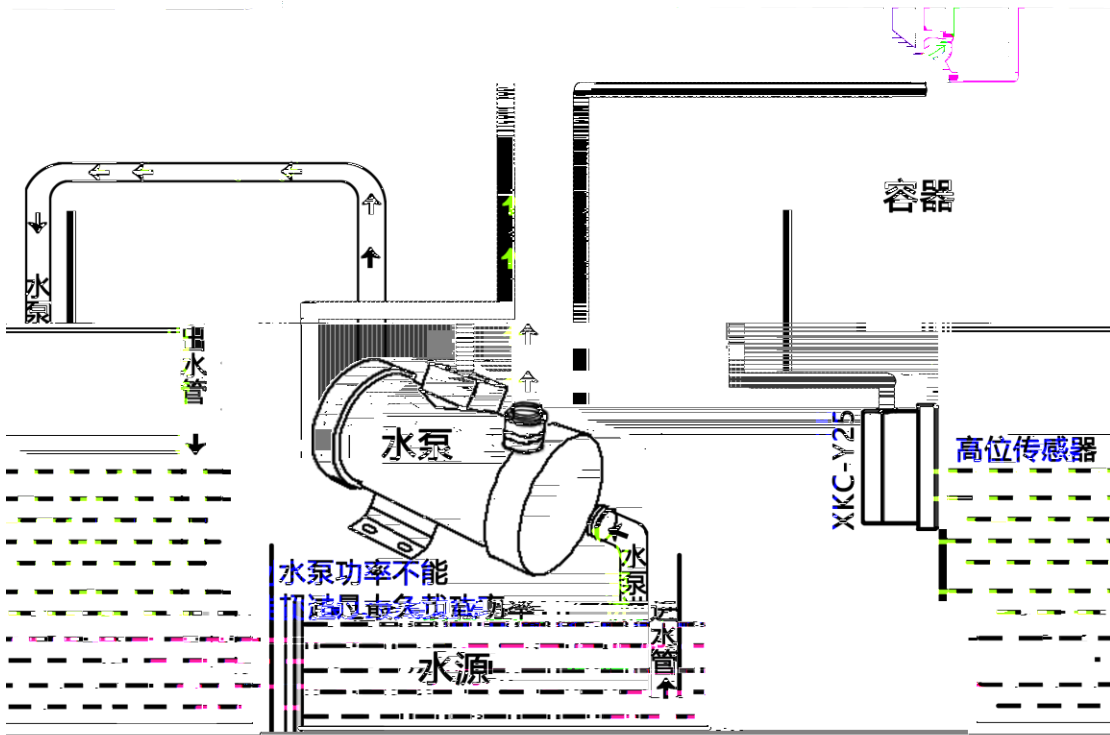



输入AC 110V-220V

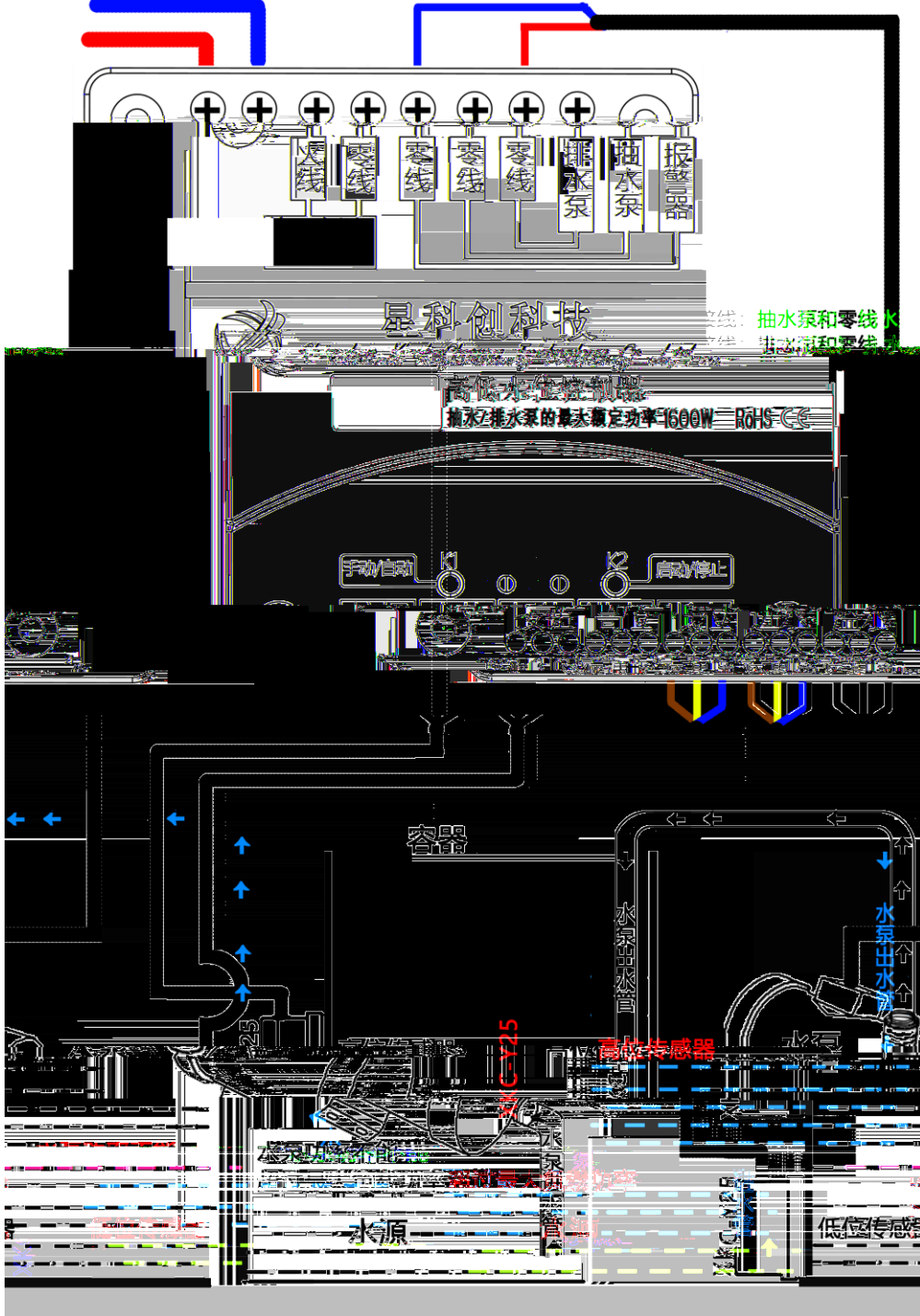



输入AC 110V-220V

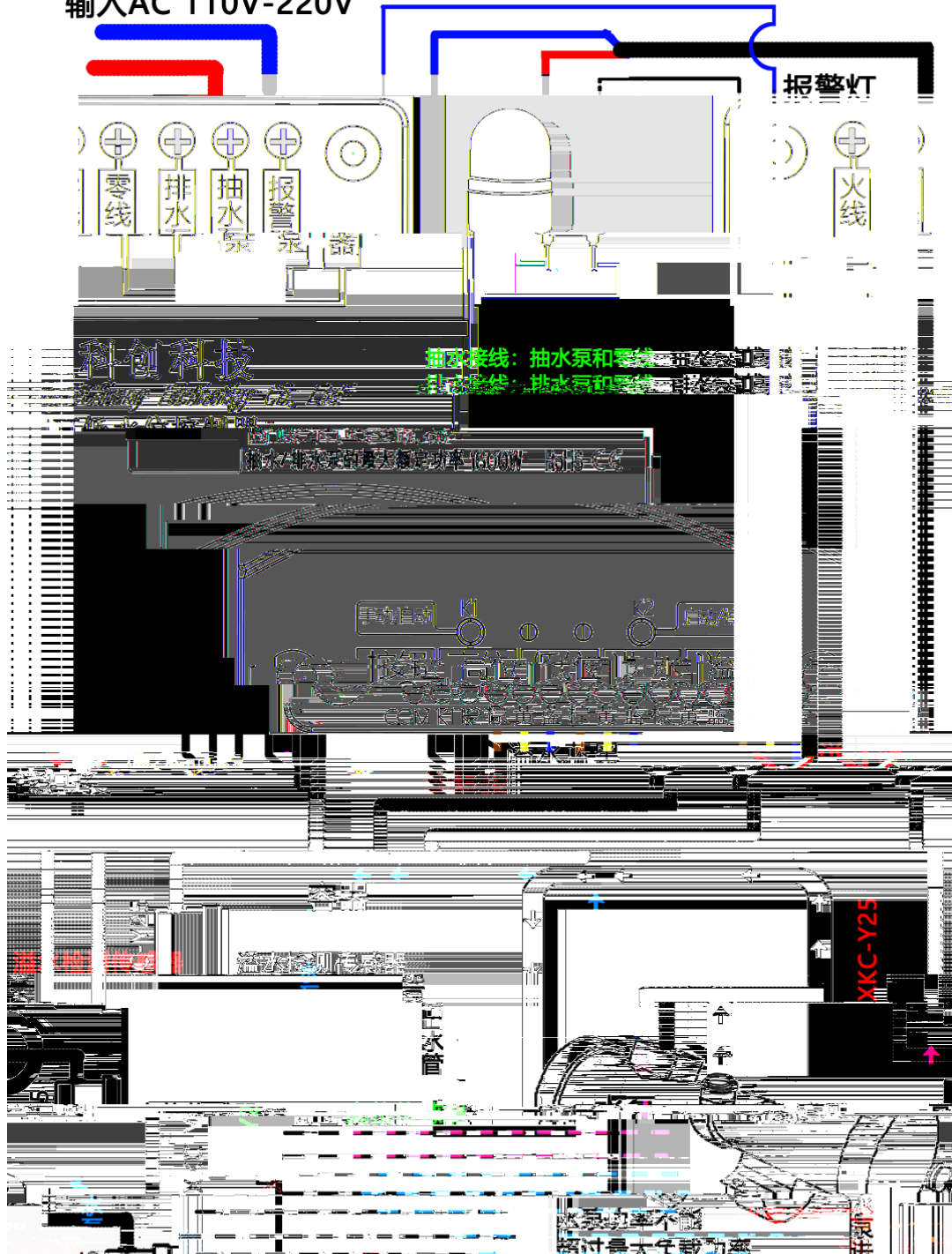



九

输入AC 110V-220V

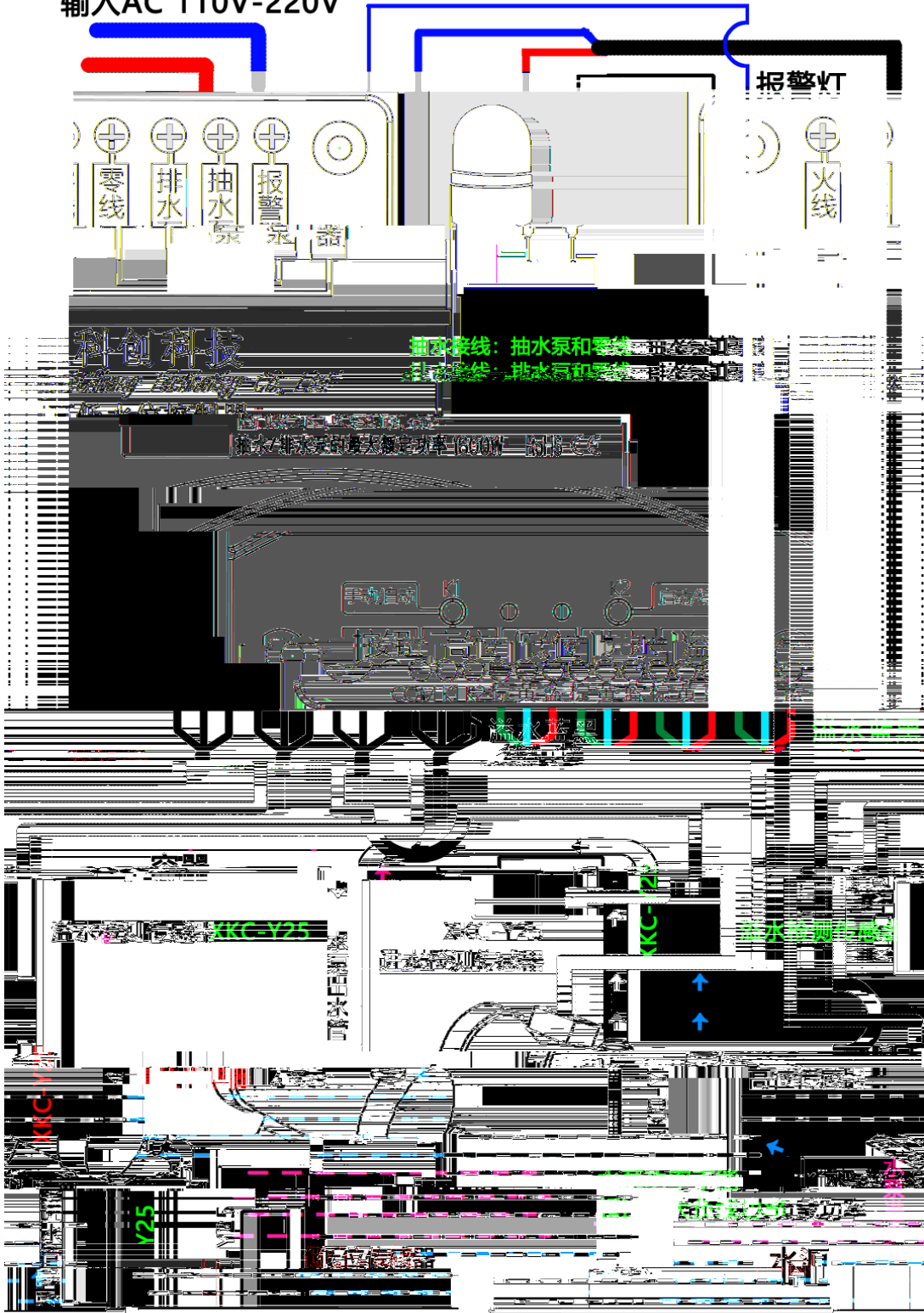



8

8

8

H4

8

7

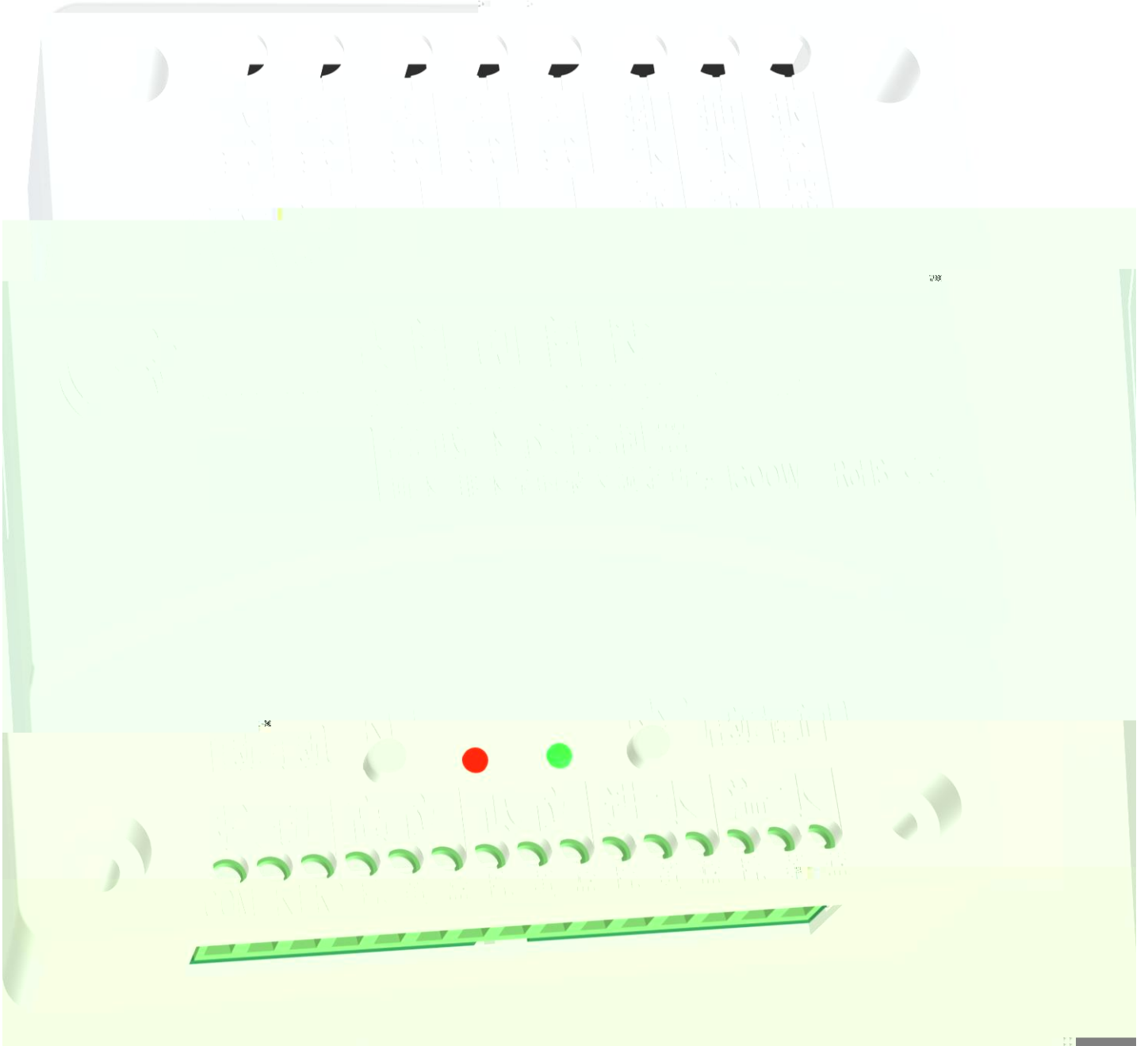



8 8 8 H4 8 7

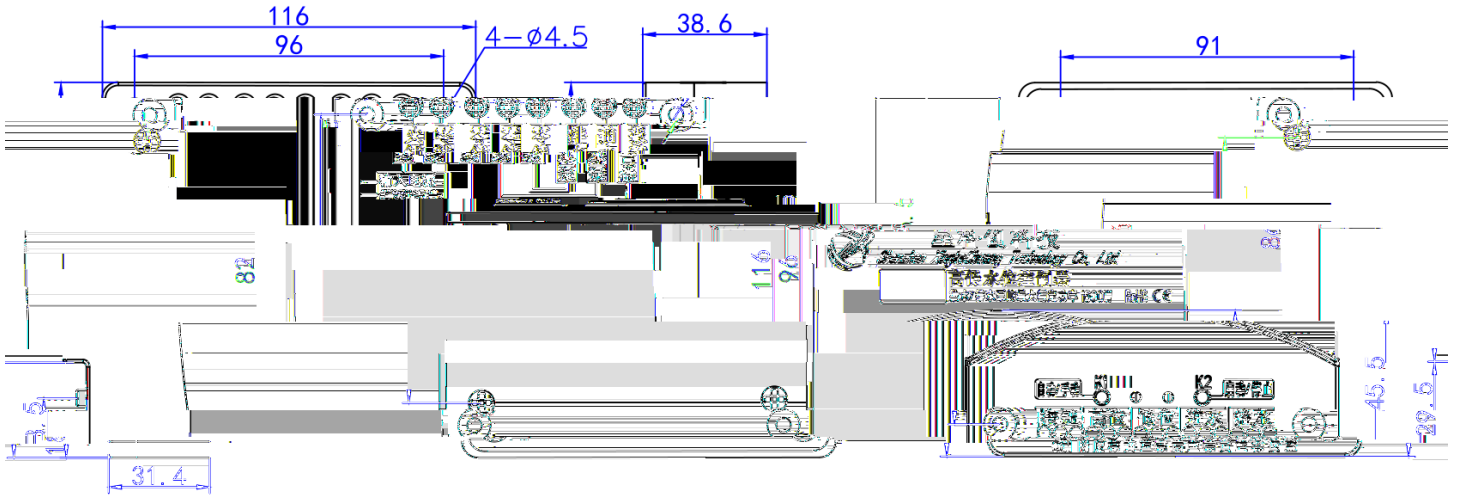

与

仔

九

仔

仔

丝

个

个

买

买

买

个

买

买

个

个

从

个

九

九

个

个

个

买

买

且九

个

个

个

个

为

K



8 8 8 H4 8 7

买

个 七 且 个 买 九 为